

DATASHEET

NI 9207

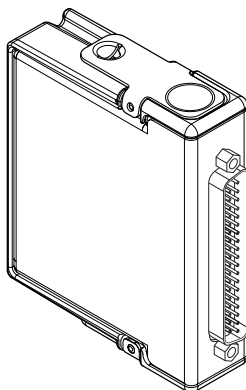

16 AI, ± 20 mA/ ± 10 V, 24 Bit, 500 S/s Aggregate

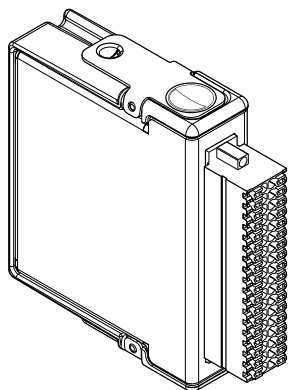

- 8 current and 8 voltage inputs, 500 S/s
- ± 20 mA current inputs, ± 10 V voltage inputs, 24-bit resolution
- High-Resolution Mode with 50/60 Hz rejection
- 250 Vrms, CAT II, channel-to-earth isolation (spring terminal); 60 VDC, CAT I, channel-to-earth isolation (DSUB)
- DSUB or spring-terminal connectivity
- -40 °C to 70 °C operating range, 5 g vibration, 50 g shock

The NI 9207 combination voltage and current input C Series module has eight channels of ± 20 mA input and eight channels of ± 10 V input with built-in 50/60 Hz rejection for noise rejection.

Designed with industrial systems in mind, the NI 9207 combines the two most common inputs to reduce the overall number of modules you need. A system that uses fewer modules has the benefit of leaving slots open for other measurement types or reducing the overall cost and size of the system. The NI 9207 has a standard 37-pin DSUB and 36-pin spring terminal connections for use with cables and connector blocks.

	Kit Contents	<ul style="list-style-type: none"> • NI 9207 • NI 9207 Getting Started Guide
	Accessories	<ul style="list-style-type: none"> • NI 9940 Backshell Connector Kit (Spring Terminal) • NI 9923 Screw-Terminal Block (DSUB)

NI C Series Overview



NI provides more than 100 C Series modules for measurement, control, and communication applications. C Series modules can connect to any sensor or bus and allow for high-accuracy measurements that meet the demands of advanced data acquisition and control applications.

- Measurement-specific signal conditioning that connects to an array of sensors and signals
- Isolation options such as bank-to-bank, channel-to-channel, and channel-to-earth ground
- -40 °C to 70 °C temperature range to meet a variety of application and environmental needs
- Hot-swappable

The majority of C Series modules are supported in both CompactRIO and CompactDAQ platforms and you can move modules from one platform to the other with no modification.

CompactRIO



CompactRIO combines an open-embedded architecture with small size, extreme ruggedness, and C Series modules in a platform powered by the NI LabVIEW reconfigurable I/O (RIO) architecture. Each system contains an FPGA for custom timing, triggering, and processing with a wide array of available modular I/O to meet any embedded application requirement.

CompactDAQ

CompactDAQ is a portable, rugged data acquisition platform that integrates connectivity, data acquisition, and signal conditioning into modular I/O for directly interfacing to any sensor or signal. Using CompactDAQ with LabVIEW, you can easily customize how you acquire, analyze, visualize, and manage your measurement data.



Software

LabVIEW Professional Development System for Windows



- Use advanced software tools for large project development
- Generate code automatically using DAQ Assistant and Instrument I/O Assistant
- Use advanced measurement analysis and digital signal processing
- Take advantage of open connectivity with DLLs, ActiveX, and .NET objects
- Build DLLs, executables, and MSI installers

NI LabVIEW FPGA Module

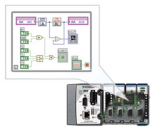

- Design FPGA applications for NI RIO hardware
- Program with the same graphical environment used for desktop and real-time applications
- Execute control algorithms with loop rates up to 300 MHz
- Implement custom timing and triggering logic, digital protocols, and DSP algorithms
- Incorporate existing HDL code and third-party IP including Xilinx IP generator functions
- Purchase as part of the LabVIEW Embedded Control and Monitoring Suite

NI LabVIEW Real-Time Module

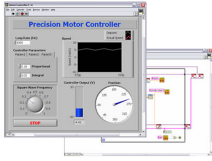

- Design deterministic real-time applications with LabVIEW graphical programming
- Download to dedicated NI or third-party hardware for reliable execution and a wide selection of I/O
- Take advantage of built-in PID control, signal processing, and analysis functions
- Automatically take advantage of multicore CPUs or set processor affinity manually
- Take advantage of real-time OS, development and debugging support, and board support
- Purchase individually or as part of a LabVIEW suite

Circuitry

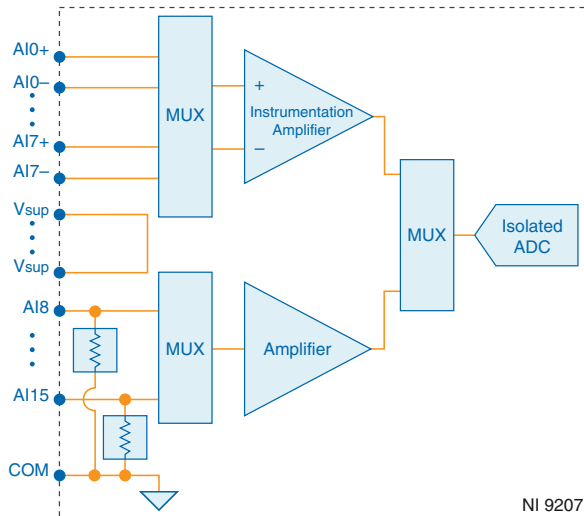

The input signals are scanned, amplified, conditioned, and then sampled by a single 24-bit ADC.

NI 9207 Specifications

The following specifications are typical for the range -40 °C to 70 °C unless otherwise noted. All voltages are relative to COM unless otherwise noted.



Caution Do not operate the NI 9207 in a manner not specified in this document. Product misuse can result in a hazard. You can compromise the safety protection built into the product if the product is damaged in any way. If the product is damaged, return it to NI for repair.

Input Characteristics

Number of channels	16 analog input channels: 8 voltage and 8 current
ADC resolution	24 bits
Type of ADC	Delta-Sigma
Sampling mode	Scanned
Input range	
Voltage channels	
Minimum	± 10.2 V
Typical	± 10.4 V
Current channels	
Minimum	± 21.5 mA
Typical	± 22.0 mA
Maximum working voltage for analog inputs (signal voltage + common mode voltage), voltage channels only	Each channel must remain within ± 10.2 V of common
Conversion time (per channel)	
High-Resolution Mode	52 ms
High-Speed Mode	2 ms
Overvoltage protection, channel-to-COM, all channels	± 30 V maximum on one channel at a time
Vsup pins, current channels only	
Current	2 A maximum
Voltage	0 to 30 V maximum
Input impedance	
Voltage channels	>1 G Ω
Current channels	85 Ω

Table 1. Accuracy

Calibrated Measurement Conditions	Channels	Percent of Reading (Gain Error)	Percent of Range ¹ (Offset Error)
Maximum (-40 °C to 70 °C)	Voltage channels	±0.52%	±0.04%
	Current channels	±0.87%	±0.05%

Input noise

Voltage channels

High-Resolution Mode	16 µVrms
----------------------	----------

High-Speed Mode	80 µVrms
-----------------	----------

Current channels

High-Resolution Mode	50 nArms
----------------------	----------

High-Speed Mode	200 nArms
-----------------	-----------

Stability

Voltage channels

Gain drift	±21 ppm/°C
------------	------------

Offset drift	±14 µV/°C
--------------	-----------

Current channels

Gain drift	±43 ppm/°C
------------	------------

Offset drift	±30 nA/°C
--------------	-----------

CMRR (f_{in} = 0 Hz to 60 Hz), voltage channels only	86 dB
---	-------

CMRR, channel-to-earth ground (50/60 Hz) ²	
---	--

High-Resolution Mode	160 dB
----------------------	--------

High-Speed Mode	120 dB
-----------------	--------

NMRR (High-Resolution Mode only)	
----------------------------------	--

50 Hz	66 dB
-------	-------

60 Hz	68 dB
-------	-------

¹ Range equals 10.4 V for voltage channels and 22.0 mA for current channels.

² Voltage channel of NI 9207 with spring terminal only.

Power Requirements

Power consumption from chassis

Active mode	295 mW maximum
Sleep mode	25 μ W maximum

Thermal dissipation (at -40 °C)

Active mode	0.75 W maximum
Sleep mode	0.59 W maximum

Physical Characteristics

If you need to clean the module, wipe it with a dry towel.



Tip For two-dimensional drawings and three-dimensional models of the C Series module and connectors, visit ni.com/dimensions and search by module number.

Push-in spring-terminal wiring

Gauge	0.14 mm ² to 1.5 mm ² (26 AWG to 16 AWG) copper conductor wire
Wire strip length	10 mm (0.394 in.) of insulation stripped from the end
Temperature rating	90 °C minimum
Wires per spring terminal	One wire per spring terminal; two wires per spring terminal using a 2-wire ferrule
Ferrules	0.14 mm ² to 1.5 mm ²

Connector securement

Securement type	Screw flanges provided
Torque for screw flanges	0.2 N · m (1.80 lb · in.)

Weight

NI 9207 with spring terminal	161 g (5.7 oz)
NI 9207 with DSUB	144 g (5.1 oz)

NI 9207 with Spring Terminal Safety Voltages

Connect only voltages that are within the following limits:

Isolation

Channel-to-channel	None
--------------------	------

Channel-to-earth ground

Continuous	250 Vrms, Measurement Category II
Withstand up to 5,000 m	3,000 Vrms, verified by a 5 s dielectric withstand test

Measurement Category II is for measurements performed on circuits directly connected to the electrical distribution system. This category refers to local-level electrical distribution, such as that provided by a standard wall outlet, for example, 115 V for U.S. or 230 V for Europe.



Caution Do not connect the NI 9207 to signals or use for measurements within Measurement Categories III or IV.

NI 9207 with DSUB Safety Voltages

Connect only voltages that are within the following limits:

Isolation

Channel-to-channel	None
Channel-to-earth ground	
Continuous	60 VDC, Measurement Category I
Withstand up to 2,000 m	1,000 Vrms, verified by a 5 s dielectric withstand test
Withstand up to 5,000 m	500 Vrms, verified by a 5 s dielectric withstand test

Measurement Category I is for measurements performed on circuits not directly connected to the electrical distribution system referred to as *MAINS* voltage. *MAINS* is a hazardous live electrical supply system that powers equipment. This category is for measurements of voltages from specially protected secondary circuits. Such voltage measurements include signal levels, special equipment, limited-energy parts of equipment, circuits powered by regulated low-voltage sources, and electronics.



Caution Do not connect the NI 9207 with DSUB to signals or use for measurements within Measurement Categories II, III, or IV.



Note Measurement Categories CAT I and CAT O are equivalent. These test and measurement circuits are not intended for direct connection to the *MAINS* building installations of Measurement Categories CAT II, CAT III, or CAT IV.

Hazardous Locations

U.S. (UL)	Class I, Division 2, Groups A, B, C, D, T4; Class I, Zone 2, AEx nA IIC T4
Canada (C-UL)	Class I, Division 2, Groups A, B, C, D, T4; Class I, Zone 2, Ex nA IIC T4
Europe (ATEX) and International (IECEX)	Ex nA IIC T4 Gc

Safety and Hazardous Locations Standards

This product is designed to meet the requirements of the following electrical equipment safety standards for measurement, control, and laboratory use:

- IEC 61010-1, EN 61010-1
- UL 61010-1, CSA 61010-1
- EN 60079-0:2012, EN 60079-15:2010
- IEC 60079-0: Ed 6, IEC 60079-15; Ed 4
- UL 60079-0; Ed 6, UL 60079-15; Ed 4
- CSA 60079-0:2011, CSA 60079-15:2012



Note For UL and other safety certifications, refer to the product label or the [Online Product Certification](#) section.

Electromagnetic Compatibility

This product meets the requirements of the following EMC standards for electrical equipment for measurement, control, and laboratory use:

- EN 61326-1 (IEC 61326-1): Class A emissions; Industrial immunity
- EN 55011 (CISPR 11): Group 1, Class A emissions
- EN 55022 (CISPR 22): Class A emissions
- EN 55024 (CISPR 24): Immunity
- AS/NZS CISPR 11: Group 1, Class A emissions
- AS/NZS CISPR 22: Class A emissions
- FCC 47 CFR Part 15B: Class A emissions
- ICES-001: Class A emissions



Note In the United States (per FCC 47 CFR), Class A equipment is intended for use in commercial, light-industrial, and heavy-industrial locations. In Europe, Canada, Australia and New Zealand (per CISPR 11) Class A equipment is intended for use only in heavy-industrial locations.



Note Group 1 equipment (per CISPR 11) is any industrial, scientific, or medical equipment that does not intentionally generate radio frequency energy for the treatment of material or inspection/analysis purposes.



Note For EMC declarations and certifications, and additional information, refer to the [Online Product Certification](#) section.



Caution For EMC compliance, operate the NI 9207 with DSUB with shielded cables.

CE Compliance

This product meets the essential requirements of applicable European Directives, as follows:

- 2014/35/EU; Low-Voltage Directive (safety)
- 2014/30/EU; Electromagnetic Compatibility Directive (EMC)
- 2014/34/EU; Potentially Explosive Atmospheres (ATEX)

Online Product Certification

Refer to the product Declaration of Conformity (DoC) for additional regulatory compliance information. To obtain product certifications and the DoC for this product, visit ni.com/certification, search by model number or product line, and click the appropriate link in the Certification column.

Shock and Vibration

To meet these specifications, you must panel mount the system.

Operating vibration

Random (IEC 60068-2-64)	5 g _{rms} , 10 Hz to 500 Hz
Sinusoidal (IEC 60068-2-6)	5 g, 10 Hz to 500 Hz
Operating shock (IEC 60068-2-27)	30 g, 11 ms half sine; 50 g, 3 ms half sine; 18 shocks at 6 orientations

Environmental

Refer to the manual for the chassis you are using for more information about meeting these specifications.

Operating temperature (IEC 60068-2-1, IEC 60068-2-2)	-40 °C to 70 °C
Storage temperature (IEC 60068-2-1, IEC 60068-2-2)	-40 °C to 85 °C
Ingress protection	IP40
Operating humidity (IEC 60068-2-78)	10% RH to 90% RH, noncondensing
Storage humidity (IEC 60068-2-78)	5% RH to 95% RH, noncondensing
Pollution Degree	2
Maximum altitude	5,000 m

Indoor use only.

Environmental Management

NI is committed to designing and manufacturing products in an environmentally responsible manner. NI recognizes that eliminating certain hazardous substances from our products is beneficial to the environment and to NI customers.

For additional environmental information, refer to the *Minimize Our Environmental Impact* web page at ni.com/environment. This page contains the environmental regulations and directives with which NI complies, as well as other environmental information not included in this document.

Waste Electrical and Electronic Equipment (WEEE)



EU Customers At the end of the product life cycle, all NI products must be disposed of according to local laws and regulations. For more information about how to recycle NI products in your region, visit ni.com/environment/weee.

电子信息产品污染控制管理办法（中国 RoHS）



中国客户 National Instruments 符合中国电子信息产品中限制使用某些有害物质指令 (RoHS)。关于 National Instruments 中国 RoHS 合规性信息，请登录 ni.com/environment/rohs_china。(For information about China RoHS compliance, go to ni.com/environment/rohs_china.)

Calibration

You can obtain the calibration certificate and information about calibration services for the NI 9207 at ni.com/calibration.

Calibration interval

2 years

Refer to the *NI Trademarks and Logo Guidelines* at ni.com/trademarks for information on NI trademarks. Other product and company names mentioned herein are trademarks or trade names of their respective companies. For patents covering NI products/technology, refer to the appropriate location: **Help»Patents** in your software, the `patents.txt` file on your media, or the *National Instruments Patent Notice* at ni.com/patents. You can find information about end-user license agreements (EULAs) and third-party legal notices in the readme file for your NI product. Refer to the *Export Compliance Information* at ni.com/legal/export-compliance for the NI global trade compliance policy and how to obtain relevant HTS codes, ECCNs, and other import/export data. NI MAKES NO EXPRESS OR IMPLIED WARRANTIES AS TO THE ACCURACY OF THE INFORMATION CONTAINED HEREIN AND SHALL NOT BE LIABLE FOR ANY ERRORS. U.S. Government Customers: The data contained in this manual was developed at private expense and is subject to the applicable limited rights and restricted data rights as set forth in FAR 52.227-14, DFAR 252.227-7014, and DFAR 252.227-7015.

© 2009—2016 National Instruments. All rights reserved.